

FIRE
CLAMBELLO®
ALARM

CLAMBELL® 



The ClamBell® is the only fire alarm bell designed and manufactured in the UK. It's quick to install, approved worldwide and reassuringly reliable.

INTRODUCING THE CLAMBELL®

The ClamBell® is the first newly developed and approved bell to be launched globally in decades and the only fire alarm bell made in Europe. It has been carefully designed to combine core elements of popular existing designs with innovative new features to ensure consistent, reliable and predictable performance.

Our unique design makes the Clambell® quick to install and great to look at, while a fully controlled manufacturing process guarantees quality. It's also a truly global product thanks to EN54-3 approval, pending UL-certification and mounting options for all worldwide installation practices.



EN 54-3

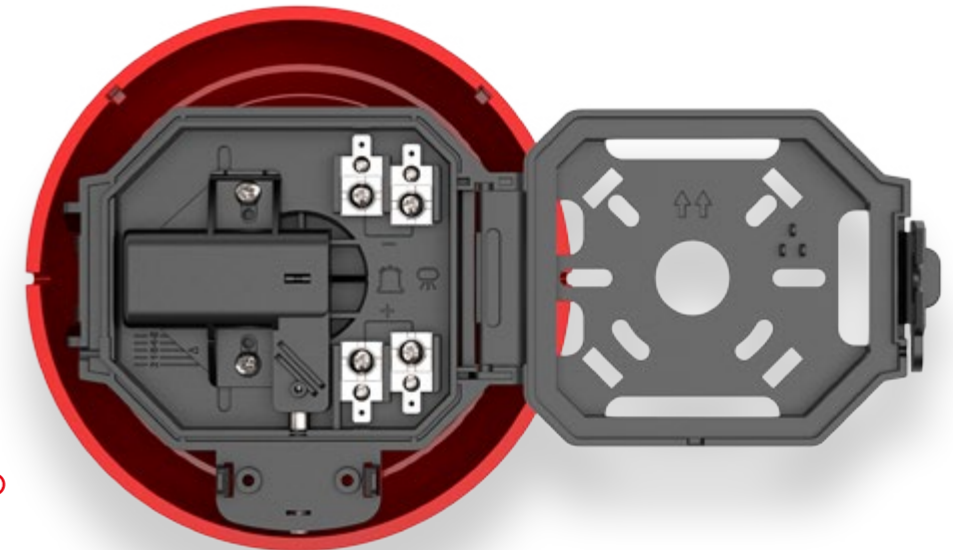













The ClamBell® is designed and manufactured in Britain by VimpeX, Europe's leading independent manufacturer and distributor of fire alarm system components.

VIMPEX

TECHNICAL SPECIFICATION

With three different base types, shallow, deep and waterproof, as well as multiple voltage variations, the ClamBell® meets the needs of the international market and has every installation method covered. Please see below for the full specification.

CLAMBELL®

Size	6" (150mm)
Base options	 Shallow Base /  Deep Base /  Waterproof
Rated Voltage	24 V d.c. / 12 V d.c. / 230 V a.c. / 120 V a.c.
Typical Sound Output	96 dB(A)
Temperature Range	Ranging from -25 - +70 C°
Humidity Range	96%
Weight	 SB 378 g /  DB 497 g /  WP 499 g
Gong Colour	 Red /  White /  Grey
Gong Construction	Aluminium
IP Rating	 SB IP21C /  DB IP33C /  WP IP56 Cat 2

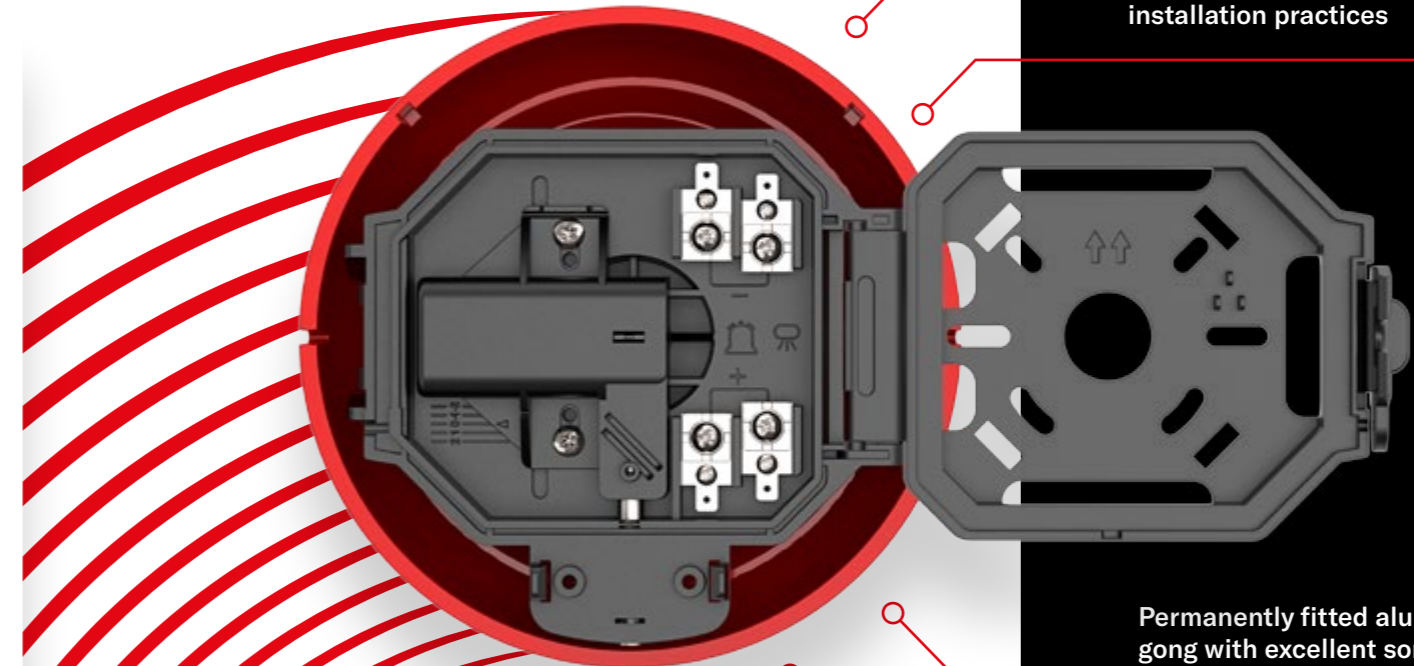

Reduced installation time thanks to an innovative new hinged design

EN54-3 approved and pending UL certification to UL464 for global use

Mounting options for all worldwide installation practices

Permanently fitted aluminium gong with excellent sonorous tone

Fully customisable with pad printed customer branding

VIMPEX

A TRULY INNOVATIVE DESIGN

It's the unique design of the ClamBell® that sets it apart from other fire alarm bells on the market and even gives the bell its name. It is called the ClamBell® because of the innovative hinged design that swings shut after installation. Together with a permanently fitted gong, this means no disassembly is required during installation.

That's not the only feature that makes the ClamBell® stand out. The ClamBell® benefits from low power consumption, a modern matt finish and multiple mounting versions. Reliable performance and excellent sonorous tone are guaranteed too, thanks to the use of an aluminium gong which also significantly reduces weight.

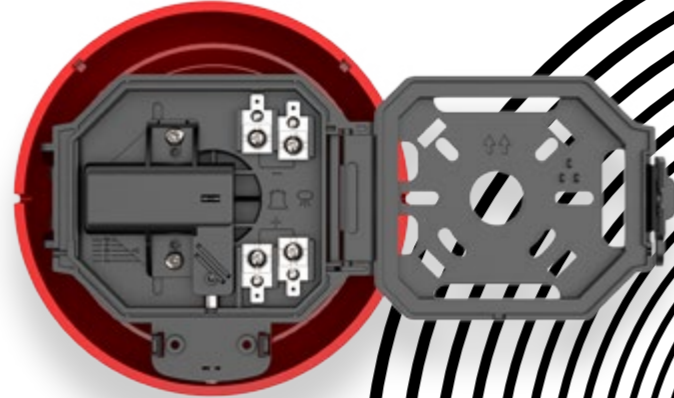

INTERNATIONAL APPROVAL

The ClamBell® is a truly global product. Thanks to careful design and manufacturing, a single model has simultaneously been approved to EN54 Part 3 by LPCB and is pending UL 464 for the U.S. market.

The ClamBell® has also been independently IP tested to IP56 by Intertek meaning true weatherproof performance.



FIRE
CLAMBELL®

VIMPEX

INSTALLED IN UNDER 2 MINUTES

The ClamBell® has a permanently fitted gong and unique hinged design, which does away with the long, complicated installation process of other bells. With no central bolt, the ClamBell® can be fitted in a matter of minutes.

All installers need to do is fit the ClamBell® to the wall, wire it to the circuit and then click it shut. It really is that easy. Three mounting options and a choice of European, Asian and US-style backplates make the installation process even easier.

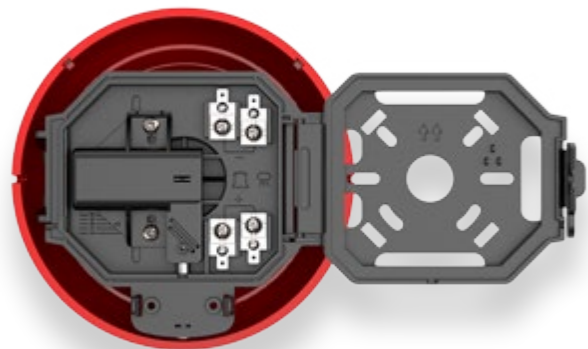

The unique hinged design makes installation quick and easy.



FULLY CUSTOMISABLE

Every ClamBell® looks great out of the box thanks to a modern textured satin paint finish. Customers have the flexibility to put their own logo on the ClamBell® to incorporate our product into your brand.

With fully customised pad printing, your design can be placed on the front of the ClamBell® at the point of manufacture*.

*Subject to whole box and minimum order quantities.



VIMPEX

ENGINEERED TO THE HIGHEST STANDARDS

We insist on a manufacturing process that produces the best quality fire alarm bell possible, one that looks great cosmetically and sounds pitch-perfect. It's made possible by the skill and dedication of our UK-based partner foundry.

Precision is everything. At every part of the process the ClamBell® is carefully monitored and inspected to ensure we are delivering a bell that has superior and consistent quality with a high-quality frequency each and every time.

Quality Control

We employ a continuous feedback loop that guarantees consistent production.

Perfect Finish

Gongs are tested for sonorous tone at the UK foundry.

Supply Chain

Fully traceable material ensures consistent performance.



The logo consists of the word "VIMPEX" in a bold, blue, sans-serif font, with a horizontal line underneath.





FIRE
STROBELL
ALARM

StroBell variant
available soon

Please contact us for
more details.

VIMPEX

Vimpex Ltd, Star Lane, Great Wakering, Essex, SS3 0PJ, UK
Vimpex Europe BV / Vimpex Sweden AB / Vimpex Fire & Safety (Ireland) Ltd

T: +44 (0) 1702 216 999 / E: sales@vimpex.co.uk / W: vimpex.co.uk

BR_3700078_REV_020